

29 148 000 CONCEALED MIXER WITH 2 VALVES

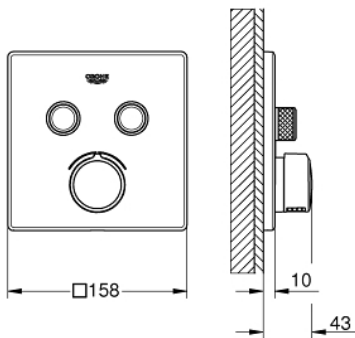

PRODUCT DESCRIPTION

- set for final installation for
- GROHE Rapido SmartBox 35 600/35 604
- metal wall escutcheon with **GROHE FastFixation** (covered escutcheon and shaft sealing, covered fixing), retroactively 6° adjustable
- **GROHE StarLight** chrome finish
-
- **GROHE SmartControl** push for ON-OFF, turn for volume adjustment from EcoJoy to full flow
- exchangeable symbols
- cartridge for temperature mixing
- multiple outlets can be run simultaneously
- **without roughing-in-set**
- flow performance:
 - outlet B = 23 l/min
 - outlet C = 25 l/min
 - outlet B + C = 27 l/min

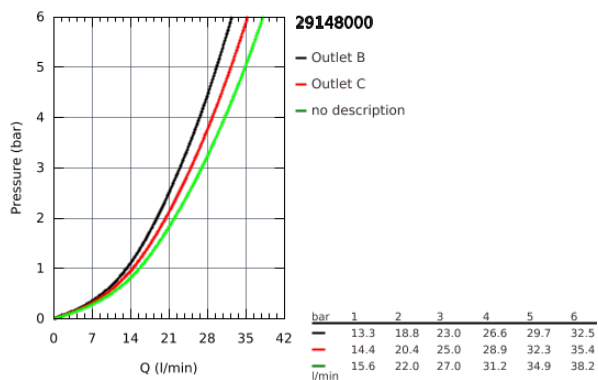

29 148 000 CONCEALED MIXER WITH 2 VALVES

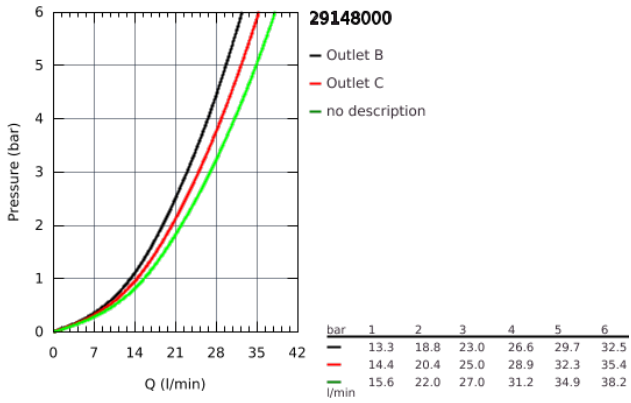

29 148 000 CONCEALED MIXER WITH 2 VALVES

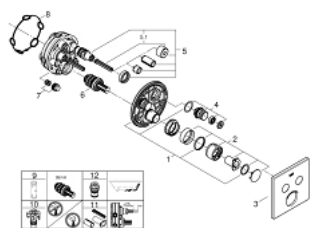

SPARE PARTS, September 2016 – now

- 1: Mounting plate (Order-nr. 48363000)
- 2: Handle (Order-nr. 46990000)
- 3: Escutcheon (Order-nr. 46995000)
- 4: WC push button (Order-nr. 48361000)
- 5: Cartridge (Order-nr. 48359000)
- 5.1: Spindle (Order-nr. 49088000)
- 6: Cartridge (Order-nr. 46989000)
- 7: Non-return valves (Order-nr. 47979000)
- 8: Sealing washer (Order-nr. 48360000)
- 9: Socket Spanner (Order-nr. 49059000)*
- 10: Service stops (Order-nr. 1405300M)*
- 11: Universal extension set single-lever mixers, 25 mm (Order-nr. 14048000)*
- 12: Backflow protection combination (DIN-EN1717) (Order-nr. 14055000)*

* Optional accessories